

DRIVER, TRACK AND RESULTS

DRIVER _____ COUNTRY _____ WEATHER AIR TEMP _____ TRACK TEMP _____ DRY INTERMEDIATE WET

RACE _____ DATE _____ QUALY POS. _____ STARTING POS. _____ FINAL POS. _____ FASTEST LAP _____

TRACK _____ TYPE INDOOR OUTDOOR STYLE TIGHT MEDIUM OPEN

SURFACE GRIP LOW MEDIUM HIGH _____ CONDITION SMOOTH ROUGH

TYPE HARD PACKED CLAY CARPET MULTI/SURFACE GRASS BLUE GROOVE DIRT ASTRO-TURF

FRONT SHOCK ABSORBERS		REAR	
cst OIL _____		cst _____	
SPRINGS _____			
mm REBOUND _____		mm _____	
mm LIMITERS _____		mm _____	
N° HOLES _____	Ø mm PISTONS	N° HOLES _____	Ø mm _____
PISTONS TYPE <input type="checkbox"/> STOCK <input type="checkbox"/> CONICAL <input type="checkbox"/> SQUARE			
<input type="checkbox"/> SHORT <input type="checkbox"/> LONG SPRING BUCKETS <input type="checkbox"/> SHORT <input type="checkbox"/> LONG			
<input type="checkbox"/> BLADDER SEAL		<input type="checkbox"/> BLADDER	
<input type="checkbox"/> EMULSION TYPE		<input type="checkbox"/> EMULSION	

FRONT ANTI-ROLL BARS		REAR	
FRONT ANTI-ROLL BAR _____ mm		REAR ANTI-ROLL BAR _____ mm	

FRONT DIFFERENTIAL		REAR	
<input type="checkbox"/> BALL DIFFERENTIAL		<input type="checkbox"/> BALL DIFFERENTIAL	
<input type="checkbox"/> GEAR DIFF _____ cst		<input type="checkbox"/> GEAR DIFF _____ cst	
FR DIFF HEIGHT		RR DIFF HEIGHT	

GEARING			
PINION _____ Teeth		SPUR GEAR _____ Teeth	

ELECTRONICS	
BATTERY	
BRAND _____	CAPACITY _____ mAh
MOTOR	
BRAND _____	TYPE _____ TIMING _____
ESC	
BRAND _____	TYPE _____

AERODYNAMIC CONFIGURATION	
BODY BRAND _____	TYPE _____
REAR WING BRAND _____	TYPE _____
REAR WING WIDTH _____	REAR WING LIP _____ mm
RR WING ANGLE <input type="checkbox"/> 0° <input type="checkbox"/> 2° <input type="checkbox"/> 4° <input type="checkbox"/> 6° <input type="checkbox"/> 8°	MOUNT <input type="checkbox"/> STD <input type="checkbox"/> LOW
FRONT WING <input type="checkbox"/> YES <input type="checkbox"/> NO	TYPE _____

FRONT TIRES		REAR	
MAKE _____		MAKE _____	
TYPE _____		TYPE _____	
COMPOUND _____		COMPOUND _____	
INSERTS _____		INSERTS _____	
WHEELS _____		WHEELS _____	
ADDITIVE _____		ADDITIVE _____	

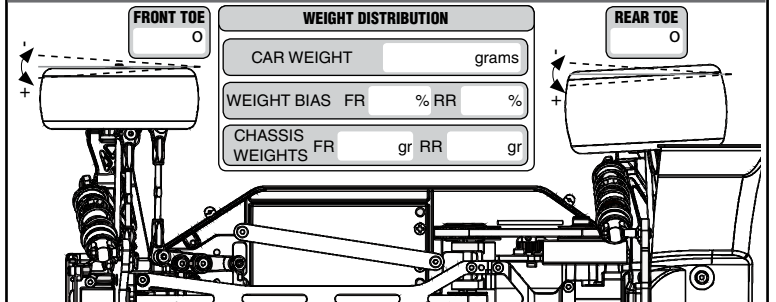
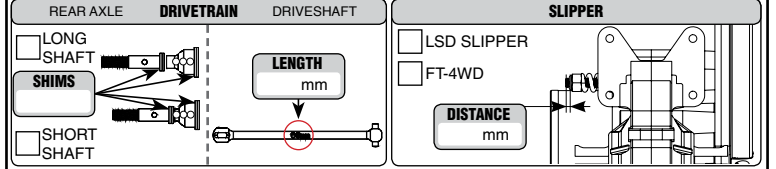
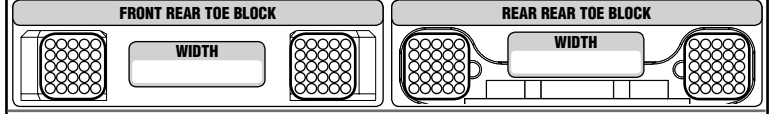
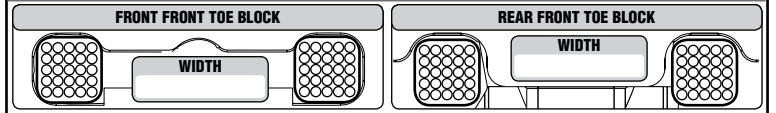
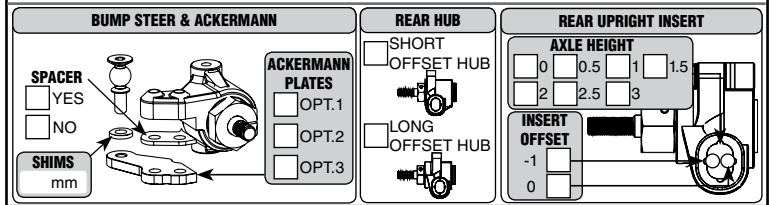
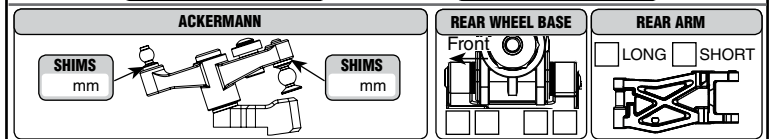
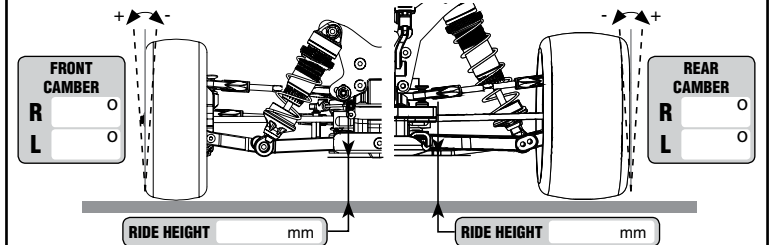
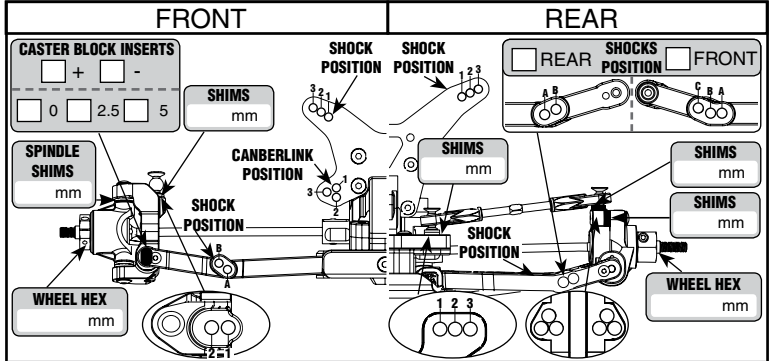

REMARKS _____